



Ethernet Module

ETHM-2



Firmware version 1.0

ethm2_en 09/08

SATEL sp. z o.o.
ul. Schuberta 79
80-172 Gdańsk
POLAND
tel. + 48 58 320 94 00
info@satel.pl
www.satel.pl

SATEL's goal is to continually improve the quality of its products, which may result in alteration of their technical specifications and firmware. Current information on the introduced modifications is available on our website.

Please visit us at:
<http://www.satel.pl>

The ETHM-2 Ethernet module is a dedicated device for use in intruder alarm systems for reporting purposes. It enables sending event codes via the Ethernet network (TCP/IP) to the STAM-2 monitoring station or SMET-256 converter. The module can interface with any alarm control panel (even if is not provided with telephone dialer). It converts codes received in telephone transmission format and generates codes if there are any input violations, output activations, etc. In the event of codes generated by the module, information on the event can also be sent by e-mail messages.

1. FEATURES OF ETHM-2 ETHERNET MODULE

- Simulation of analog telephone line.
- Capability to receive monitoring events sent in telephone transmission format (Ademco Slow, Silent Knight fast, Radionics 1400, Radionics 1400 with parity, Ademco Express or Contact ID) and report them to the monitoring station through Ethernet with the use of TCP/IP protocols.
- Acknowledgment of event receipt.
- Buffer for 512 received events.
- Coded event transmission.
- 8 inputs.
- 4 outputs.
- Remote control of output status.
- Power supply output.
- Monitoring of the status of inputs, outputs, power supply, communications, etc. by means of codes sent through Ethernet network to 2 monitoring stations and/or by means of e-mail messages.
- Module configuration through the RS-232 port (ETHM-2 Soft program) or Ethernet (web browser).
- Control of Ethernet cable availability.
- Module firmware updating capability.
- Built-in switching power supply 1.2 A.
- Battery charging and control system.
- Power supplied with 16 V AC ($\pm 10\%$) or 12 V DC ($\pm 15\%$).

2. DESCRIPTION OF ELECTRONICS BOARD

Terminals description:

- AC** – power supply input (16 V AC $\pm 10\%$).
- COM** – common ground.
- +12V** – power supply output (if supplied with alternating voltage) or power supply input (12 V DC $\pm 15\%$).
- OUT1...OUT4** – OC type low-current outputs with current-carrying capacity up to 50 mA. If active, they are shorted to ground. The outputs can be used for control of low power consumption devices (e.g. indicator LEDs, sirens with own power supply) or relays (by using relays, it is possible to control high power devices).
- Z1...Z8** – inputs. For example, alarm control panel outputs can be connected to the inputs (with the control panel and ETHM-2 module suitably programmed, this will enable monitoring the status of control panel which is not fitted with telephone dialer).

TIP, RING – terminals for connecting the control panel telephone dialer.

Note: Do not connect the telephone exchange or any devices simulating the analog telephone line to the TIP and RING terminals.

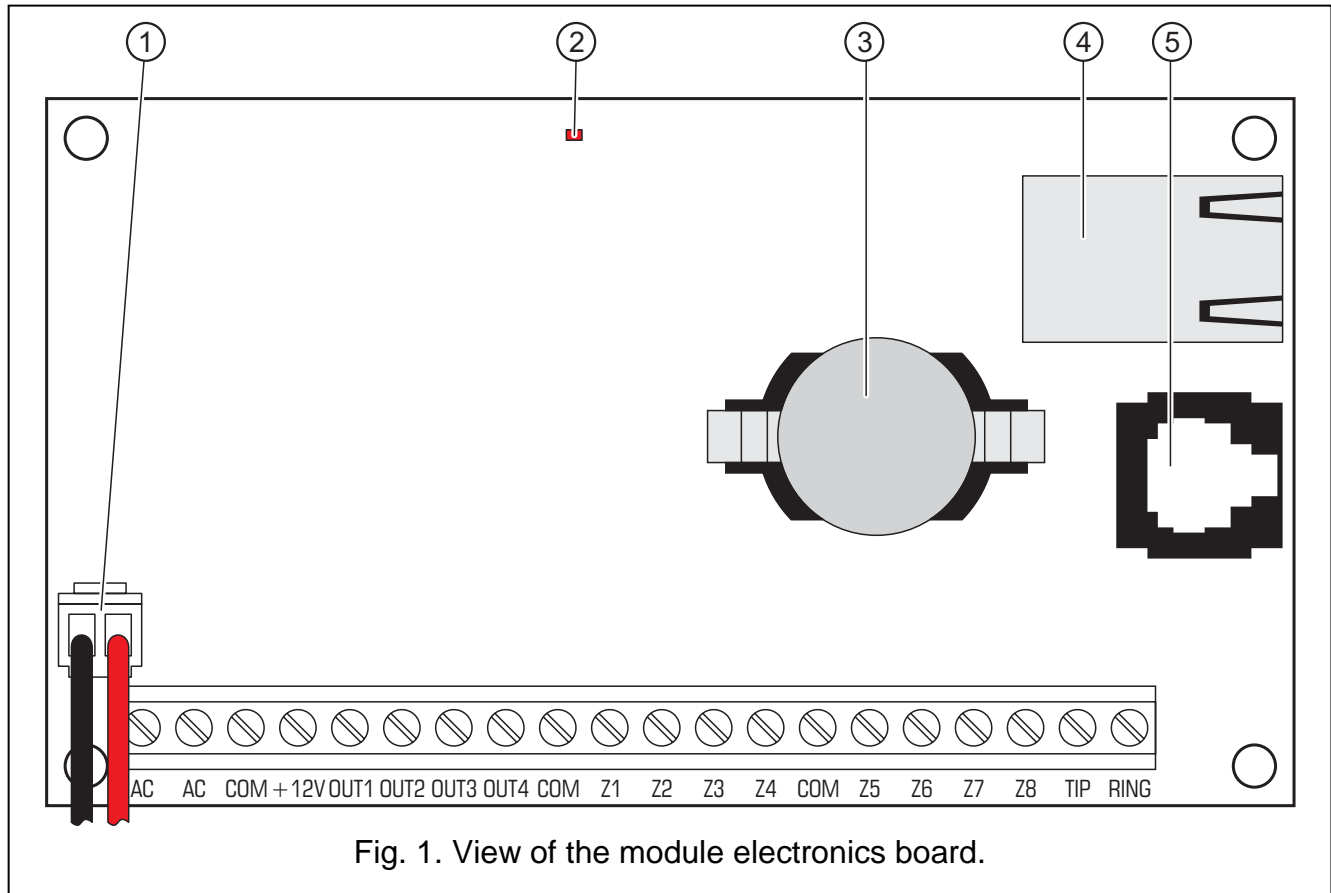

Fig. 1. View of the module electronics board.

Explanations for the figure:

- 1 – **battery connecting leads** (connect the battery only when the module is to be supplied with 16 V ($\pm 10\%$) alternating voltage).
- 2 – **LED** whose blinking indicates the module status:
 - lights up for a short while – the device operation is normal
 - blinking regularly at a slow rate – configuration data memory error
 - blinking regularly at a fast rate – module firmware update running
- 3 – **CR2032 3 V battery** for backup of the real time clock.
- 4 – **RJ-45 socket** for connecting the module to Ethernet network. 100Base-TX standard compatible cable should be used. The socket has two built-in LEDs. The green one indicates connection to the network and data transmission, and the yellow one - negotiated transmission rate (ON: 100Mb; OFF: 10Mb).
- 5 – **RS-232 port** which enables the module to be connected to the computer serial COM port. The dedicated cable for making this connection, designated DB9F/RJ, is manufactured by SATEL. Using a computer with the ETHM-2 Soft program installed, you can configure the device and read the events.

3. INSTALLATION



Disconnect power supply before making any electrical connections.

The ETHM-2 module is designed for indoor installation, in spaces with normal humidity of air. The module can be supplied with alternating or direct voltage.

3.1 CONNECTION OF ALTERNATING VOLTAGE

If the module is to be supplied with 16 V AC ($\pm 10\%$), it is recommended that a 20 VA transformer be used. The transformer should be permanently connected to the 230 V AC mains power supply. Therefore, prior to making any cable connections, familiarize yourself with the site electrical installation. The circuit to be chosen as power supply circuit is to be alive at all times and provided with suitable protection.



Never connect two devices with power supply unit to one transformer.

Before cutting in the transformer to the circuit from which it will be power supplied, deenergize the circuit.

Because the ETHM-2 module has no switch to disconnect the mains power supply, it is important that you advise the owner / user of the equipment on how it should be disconnected from the mains (e.g. by indicating the fuse which protects the power circuit of the module).

Use a 12 V/7 Ah battery as an emergency power supply source for the module.

1. Connect AC voltage from the transformer secondary winding to the module AC terminals.
2. Switch on 230 V AC power supply in the circuit to which the transformer is connected. Measure the voltage across the battery leads (the correct value should be between 13.6 and 13.8 V DC).
3. Switch off 230 V AC power supply.
4. Connect the battery. The module will not start on connecting the battery alone.
5. Switch on 230 V AC power supply. The module is now ready for operation.

Notes:

- *A battery voltage drop below 11 V for longer than 12 minutes (3 battery tests) is recognized as battery discharge. The further voltage drop to approx. 9.5 V will disconnect the battery.*
- *Additionally, if the module is supplied with AC voltage and the control panel dialer is connected to the TIP and RING terminals, the COM terminals in panel and module must be shorted. Thus will prevent the situation when simulating telephone line trouble by the module fails to be correctly recognized by the control panel.*

3.2 CONNECTION OF DIRECT VOLTAGE

If the module is to be supplied with 12 V DC ($\pm 15\%$), the power supply can be provided e.g. from the alarm control panel, which is to be monitored by means of the module. The power supply and common ground cables should be connected to the corresponding module terminals (+12V and COM). Turn on power supply to make the module ready for operation.

4. MODULE CONFIGURATION

Note: *The device is only designed for working in the local computer networks (LAN). It cannot be directly connected to the public computer network (MAN, WAN). Connection to the public network should be established by using an xDSL router or modem.*

There are 2 available methods of the module configuration:

1. Via Ethernet network, by means of a web browser.
2. Through the RS-232 port, by means of the ETHM-2 Soft program.

In both cases you must install on your computer the Java Virtual Machine, which can be found on the CD included in the device delivery set. The CD also includes the ETHM-2 Soft installation program.

4.1 WEB BROWSER

1. Start the web browser.
2. Enter the module IP address in the "Address" field. By default, the 192.168.1.100 address is set in the module.
3. The browser will display the login page. Enter the following information:
 - user name (by default: "service")
 - password (by default: "service").

Note: The module can distinguish between two types of users. If you enter the name and password of a user with limited authority (see section LOGGING DETAILS), you will be only allowed to control the outputs and view the event log.

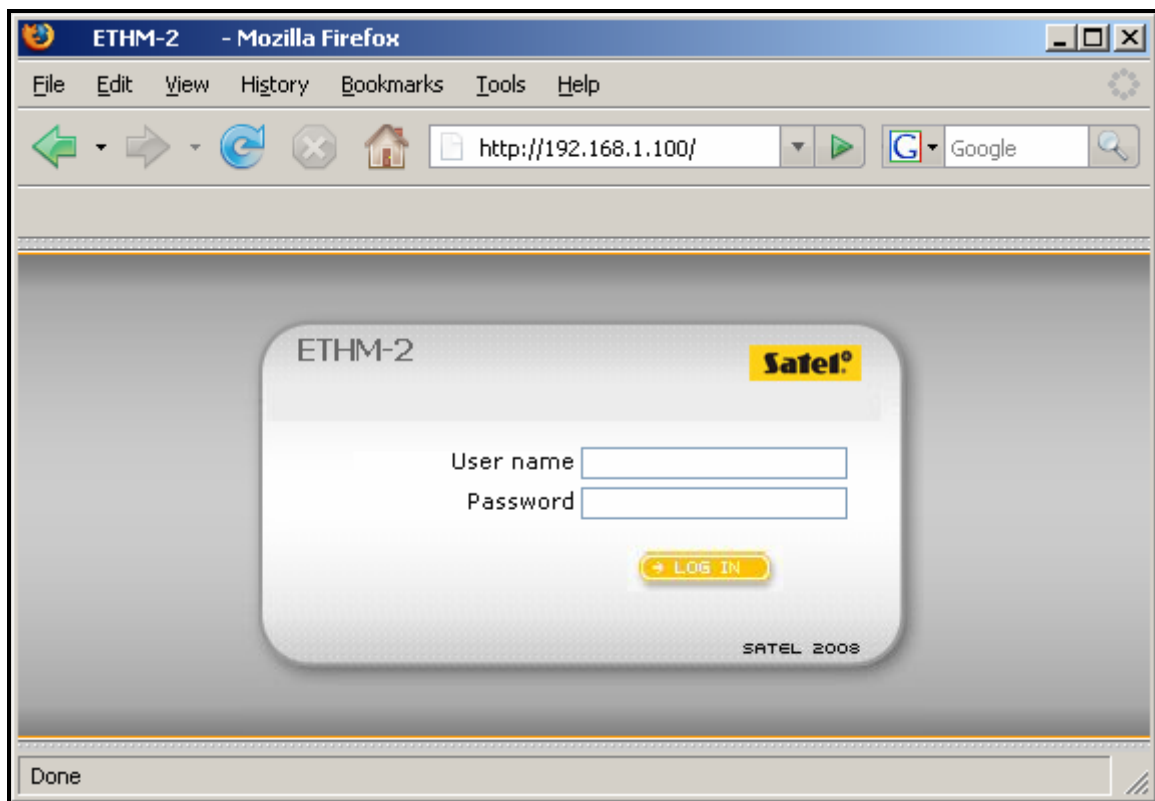



Fig. 2. Browser window with the login page.

4. Click on the "Log in" button. The browser window will display a Java applet to enable module configuration. The data will be automatically downloaded from the module.
5. Configure the module settings as required.
6. Save the data to the module.

4.2 ETHM-2 SOFT PROGRAM

1. Connect the module RS-232 port (RJ type socket) to the computer COM serial port. The method of connection is shown in Figure 3 (you can buy a ready-made cable, manufactured by SATEL).
2. Start the ETHM-2 Soft program.
3. Select in the program window the computer COM port to which the module is connected.

4. Click on the  symbol to initiate communication with the module. Data will be automatically downloaded from the module.
5. Configure the module settings as required.
6. Save the data to the module.

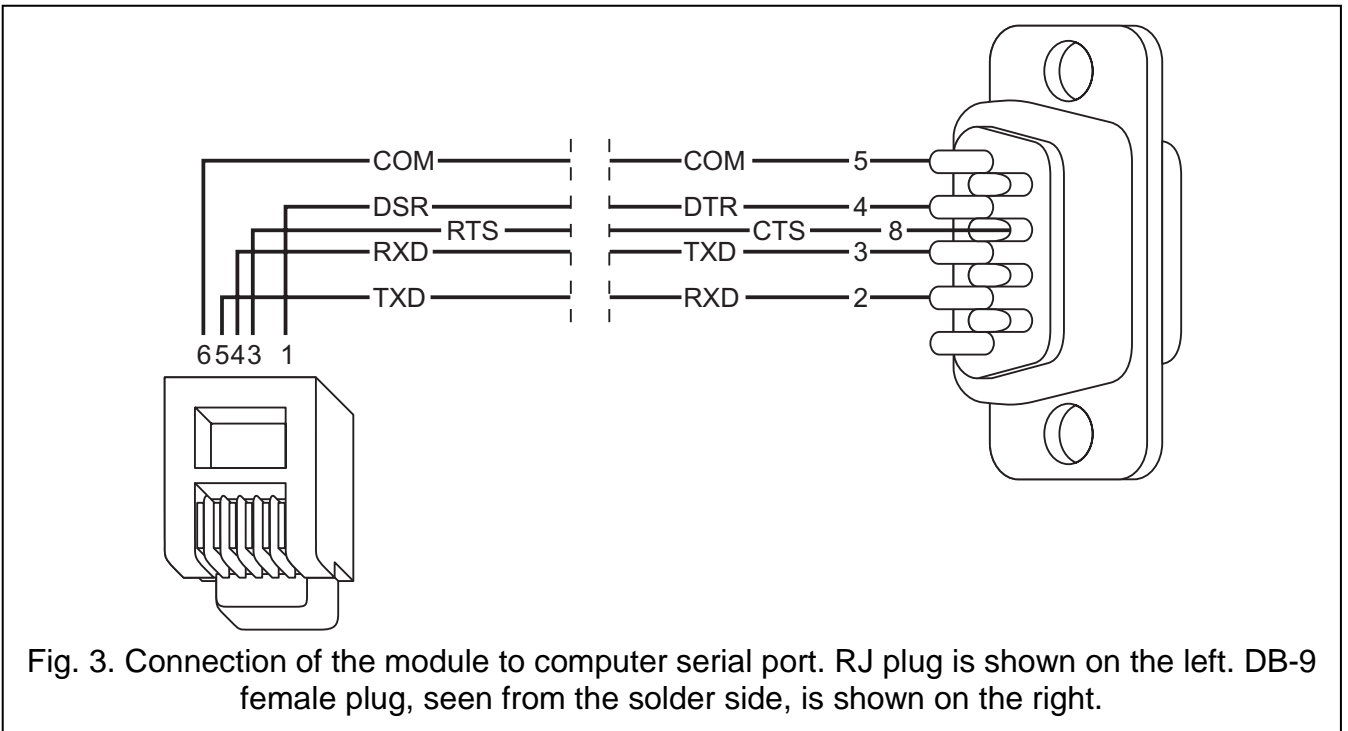



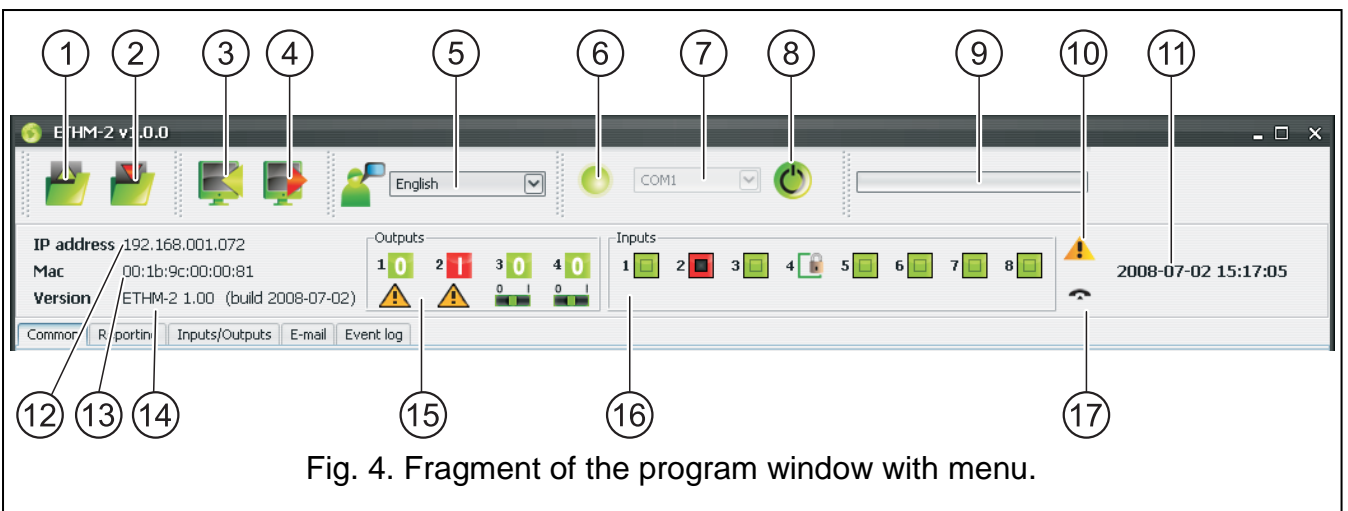







4.3 MAIN MENU



Explanations for Fig. 4:

- 1 - button enabling the configuration data to be loaded from file. Not available in web browser.
- 2 - button enabling the configuration data to be written to file. Not available in web browser.
- 3 - button enabling the data to be read from the module.
- 4 - button enabling the data to be written to the module.
- 5 - field enabling selection of the program language.
- 6 - icon indicating the status of communication with the module (green color – the program is connected to the module; gray color – no connection with the module). The icon is not available in web browser.

- 7 - field enabling selection of the computer COM port, through which communication with the module will be effected. The field is not available in web browser.
- 8 - button enabling communication with the module to be switched on/off. Not available in web browser.
- 9 - information on the progress of writing/reading data.
- 10 - icon indicating troubles (grayed if there is no trouble).
- 11 - time by the module clock.
- 12 - IP address of the module.
- 13 - MAC number of the module.
- 14 - module firmware version.
- 15 - information on outputs. Placed in the upper line are icons indicating the status of outputs:
 -  - output inactive;
 -  - output active;
 Placed in the lower line are icons related to the function of outputs:
 -  - the output is signaling trouble and cannot be controlled;
 -  - the output can be controlled by means of inputs or program. Click on 0 to disable the output; click on 1 to enable it (for the time programmed in the INPUTS/OUTPUTS tab).
- 16 - information on the status of inputs:
 -  - input status OK;
 -  - input bypassed;
 -  - input violated.
- 17 - status of simulated telephone line:
 -  - module ready for answering telephone calls;
 -  - module is answering a telephone call;
 -  - module is simulating telephone line trouble (e.g. Ethernet not available).

4.4 „COMMON” TAB

4.4.1 Network

Dynamic IP address – select this option, if the data regarding IP address, subnet mask and gateway are to be automatically downloaded from DHCP server.

Static IP address – select this option, if the data regarding IP address, subnet mask and gateway will be entered manually.

IP address – IP address of the module.

Subnet mask – mask of the subnet in which the module operates.

Default gateway – net gateway i.e. IP address of the network device through which the other devices in the given local network communicate with devices in other networks.

Obtain DNS server address automatically – select this option if the DNS server network address is to be automatically obtained from DHCP server.

Use the DNS server address – select this option if the preferred DNS server data will be entered manually.

Preferred DNS server – preferred DNS server address for the module.

4.4.2 Logging detail

User – user name. Required during the procedure of logging into the module by means of web browser. The device can recognize two users:

- user with limited right of access to the device (only allowed to view the event log and control the inputs). Factory default: satel.

- user with full right of access. Factory default: service.

Password – user password. Required during the procedure of logging into the module by means of web browser. Factory default:

- for "satel" user: satel.
- for "service" user: service.

Fig. 5. „Common” tab.

HTTP port – enter in this field the number of TCP port which will be used by the web browser when displaying the module login page. You can enter any value from 1 to 65535. It must be different from that entered for the other ports. Default value: 80.

Note: *Port 80 in the computer is intended by default for the web browser. If you set another port in the module, you must first enter the IP module address in the browser and then the port number preceded by a colon.*

JAVA port – enter in this field the number of TCP port which will be used for communication with the JAVA applet in web browser. You can enter any value from 1 to 65535. The value must be different from that entered for the other ports. Default value: 33333.

4.4.3 Clock

Summer/winter time – the module can automatically correct the clock settings due to a change from summer time to winter time and conversely. You can choose from the following correction patterns:

- no correction
- by the European Union rules
- by the United States rules
- 1 hour correction according to dates
- 2 hours correction according to dates

Summer time since – the field is available when the module clock settings are to be corrected by 1 or 2 hours according to dates. You can enter the date (day, month) when the module clock will be changed to summer time (i.e. shifted forward).

Winter time since – the field is available when the module clock settings are to be corrected by 1 or 2 hours according to dates. You can enter the date (day, month) when the module clock will be changed to winter time (i.e. shifted back).

Time synchronization – if this box is selected, the module will automatically synchronize its clock with the time server once a day and just after a restart. In the event of failure, the module will be repeating the clock synchronization attempt every minute.

Time server (NTP) – enter in this field the IP address of the time server supporting the NTP protocol.

Time zone – enter in this field the time zone, i.e. the difference between the universal time (UTC) and the zone time.

System time – this field displays the computer clock based time.

Send – when you click on the button, the time displayed in the "System time" field will be saved to the module.

4.4.4 Default settings restoration

Configuration – select the box and click on the "Restore values" button to reset all the module settings to their factory default values.

Event log – select the box and click on the "Restore values" button to delete the event log, i.e. all events, the reception of which was acknowledged by the module, but which have not been sent yet to the monitoring station.

Note: *The procedure of restoring factory settings/deleting event log is followed by restart of the device.*

4.5 „REPORTING” TAB

The screenshot displays the 'Reporting' tab of a software interface, divided into two main sections: Station 1 and Station 2.

Station 1 Configuration:

- Reporting format:** Radio buttons for 'Normal' and 'Contact ID' (selected).
- Active inputs/outputs:** Checkboxes for Input 1-8 and Output 1-4.
- Monitored events:** Checkboxes for Module restart, Lack of AC supply, Low Battery, Problem with transmission to station 1, Problem with transmission to station 2, Test transmissions, and Supply output overload.
- Monitoring station settings:**
 - Server address: monitoring.station.com
 - Port: 12345
 - Encryption key: [masked]
 - System identifier: 11&3
 - ETHM key: cd48a
- Telephone line:**
 - Tel. number: 555444333
 - Extended kiss-off: [checkbox]
- Test transmissions:** Radio buttons for 'On time' and 'After time' (selected). Fields for Days (05) and Hours (23:00).

Station 2 Configuration:

- Event log table:**

Event	Contact ID	Normal	...
Module restart	1-305-00-000 : System r...	00	...
Power supply failure	1-301-01-000 : AC loss	00	...
Power supply restore	3-301-01-000 : AC restore	00	...
Low battery	1-302-01-000 : Low syst...	00	...
Battery OK	3-302-01-000 : System ...	00	...
Loss of communication ...	1-350-01-011 : Communi...	00	...
Restore of communicati...	3-350-01-011 : Communi...	00	...
Loss of communication ...	1-350-01-022 : Communi...	00	...
Restore of communicati...	3-350-01-022 : Communi...	00	...
Test transmission	1-602-01-000 : Periodic ...	00	...
Supply output overload	1-312-01-000 : Power s...	00	...
End of supply output ov...	3-312-01-000 : End of p...	00	...
Input 1 violation	1-130-00-001 : Burglary	00	...
Input 1 restore	3-130-00-001 : Burglary ...	00	...
Input 2 violation	1-130-00-002 : Burglary	00	...
Input 2 restore	3-130-00-002 : Burglary ...	00	...
Input 3 violation	1-130-00-003 : Burglary	00	...
Input 3 restore	3-130-00-003 : Burglary ...	00	...
Input 4 violation	1-130-00-004 : Burglary	00	...
Input 4 restore	3-130-00-004 : Burglary ...	00	...
Input 5 violation	1-130-00-005 : Burglary	00	...
Input 5 restore	3-130-00-005 : Burglary ...	00	...
Input 6 violation	1-130-00-006 : Burglary	00	...
Input 6 restore	3-130-00-006 : Burglary ...	00	...
Input 7 violation	1-130-00-007 : Burglary	00	...
Input 7 restore	3-130-00-007 : Burglary ...	00	...
Input 8 violation	1-130-00-008 : Burglary	00	...
Input 8 restore	3-130-00-008 : Burglary ...	00	...
Output 1 ON	3-407-00-001 : Remote ...	00	...
Output 1 OFF	3-407-00-001 : Remote ...	00	...

Fig. 6. „Reporting” tab.

4.5.1 Station 1 / Station 2

Active – select the box if the events are to be sent to the chosen monitoring station.

4.5.1.1 „Common” tab

Reporting format

Selection of the reporting format only applies to the event codes generated by the module (input monitoring, troubles, etc.). The events received through telephone line are sent to the monitoring station in the same format in which they were received.

Normal – select this option if the module generated events are to be sent in 4/2 format.

Contact ID – select this option if the module generated events are to be sent in Contact ID format.

Active inputs/outputs

If the box at chosen input/output is selected, the status of the input/output will be monitored. Input violation/end of violation or output activation/deactivation will result in sending an event code. The codes are defined in the "Event codes" tab.

Monitored events

If the box at chosen event is selected, occurrence of the event (and, in case of troubles, also the end of trouble) will result in sending codes defined in the "Event codes" tab to the monitoring station. The following events can be monitored:

- Module restart
- Lack of AC supply (the trouble is reported with a delay, as defined in the "Inputs/Outputs" tab)
- Low battery
- Problem with transmission to station 1
- Problem with transmission to station 2
- Test transmissions (this event requires defining test transmission rules)
- Supply output overload

Monitoring station settings

Server address – network address of the monitoring station.

Port – enter in this field the number of TCP port through which communication with the monitoring station will be effected. You can enter any value from 1 to 65535. By default: 12345.

Encryption key – enter in this field a sequence of 1 to 12 alphanumeric characters (digits, letters and special characters) to define the key for coding of the data to be sent to the monitoring station.

System identifier – enter in this field a sequence of 4 characters for identification of the device. You can enter digits from 0 to 9 and letters from A to F. Using the digit 0 is not recommended. Factory default: 0000 (this string is equivalent to the lack of identifier). Together with the identifier, the codes of module generated events will be sent (inputs monitoring, troubles, etc.).

ETHM key – enter in this field a sequence of 1 to 5 alphanumeric characters for identification of the Ethernet module.

Note: *The data entered in the fields "Port", "Encryption key", "System identifier" and "ETHM key" must be consistent with the corresponding settings defined in the monitoring station.*

Telephone line

Tel. number – enter in this field the telephone number defined in the control panel for a given monitoring station. Based on the telephone number, the module will determine, whether to receive the event and to which monitoring station send it. If the field is blank or the entered telephone number is not consistent with that programmed in the control panel, the module will not be receiving events sent by the control panel.

Extended kiss-off – some control panels require long acknowledgement of receiving the code in Contact ID format. By default, to speed up communication, a short kiss-off signal is used in the module. The option is available after selecting the Contact ID format.

4.5.1.2 „Event codes” tab

The tab makes it possible to define codes for the module generated events.

For the 4/2 format, all codes can be defined.

For the Contact ID format, the codes are factory defined. The user can change the codes of events generated after violation of the module inputs and after activation of the outputs. Defining the code to be sent on input violation/output activation will automatically generate a code which will be sent at the input end of violation/output deactivation. You can enter the new Contact ID code manually or use the code editor. To open the code editor window, click on the button marked with three dots.

4.5.2 Test transmissions

The "Test transmission" event can be generated:

On time – every specified number of days at defined time. The first event will be generated at defined time on the same day when test transmission rules are saved to the module, or on the following day (if defined time on that particular day has already passed). Entering 0 in the "Days" field means that the event will be generated every 31 days.

After time – after a lapse of specified time (days, hours and minutes) from the last event (irrespective of whether it was a test transmission, or another event was sent). The first test transmission will be generated approx. 10 seconds after test transmission rules are saved to the module. Entering 0 in the fields "Days" and "Hours" means that no event will be generated.

Note: *The "Test transmission" event is generated irrespective of whether it is to be sent to the monitoring station or not. Disabling the feature of generating this type of events is only possible in the "After time" transmission.*

4.6 „INPUTS/OUTPUTS” TAB

4.6.1 Inputs

The following parameters can be defined for each module input:

Type – the input can be programmed as NO (normally open) or NC (normally closed).

Restore time – time that must elapse from the end of violation of the input until its normal status is restored and it is able to register a new violation. You can program either 4 seconds or 4 minutes.

Sensitivity – time that must elapse from the change of input status (i.e. opening for NC type input, closing for NO type input) so that the change can be recognized as input violation. You can program values in the range from 20 ms to 5100 ms (every 20 ms).

Bypass after – number of input violations which will result in bypassing the input. You can program values from 0 to 15. After entering 0, the input will not be bypassed.

Bypass time – time during which the input will be bypassed after occurrence of the number of violations indicated in the "Bypass after" field. The time can be programmed in minutes (up to 127 minutes) or hours (up to 127 hours). Entering 0 means that the input will be bypassed until its status is changed by means of another input (end of violation of the bypassing input) or the device is restarted.

Autoreset – time after expiry of which the violation counter will be reset. Input violation will trigger the counter. If the number of violations indicated in the "Bypass after" field occurs during that time, the input will be bypassed. If the indicated number of violations does not occur, the counter will be reset. The time can be programmed in seconds (up to 255 seconds) or minutes (up to 255 minutes). Entering 0 means that the counter of violations will not be reset.

Common Reporting **Inputs/Outputs** E-mail Event log

Inputs

	Type	Restore time	Sensitivity [20-5100ms]	Bypass after	Bypass time	Autoreset
Input 1	NC	4 s	300	10	12 [Minutes]	60 [Seconds]
Input 2	NC	4 s	800	5	1 [Hours]	60 [Seconds]
Input 3	NC	4 s	200	12	30 [Minutes]	120 [Seconds]
Input 4	NC	4 s	200	0	0 [Minutes]	5 [Minutes]
Input 5	NO	4 s	200	0	0 [Minutes]	0 [Seconds]
Input 6	NO	4 s	200	0	0 [Minutes]	0 [Seconds]
Input 7	NO	4 s	200	0	0 [Minutes]	0 [Seconds]
Input 8	NO	4 s	200	0	0 [Minutes]	0 [Seconds]

Input bypassing

Bypassed inputs

	Input 1	Input 2	Input 3	Input 4	Input 5	Input 6	Input 7	Input 8
Input 1	<input type="checkbox"/>	<input type="checkbox"/>	<input type="checkbox"/>	<input type="checkbox"/>	<input type="checkbox"/>	<input type="checkbox"/>	<input type="checkbox"/>	<input type="checkbox"/>
Input 2	<input checked="" type="checkbox"/>	<input type="checkbox"/>	<input type="checkbox"/>	<input checked="" type="checkbox"/>	<input checked="" type="checkbox"/>	<input type="checkbox"/>	<input type="checkbox"/>	<input type="checkbox"/>
Input 3	<input type="checkbox"/>	<input type="checkbox"/>	<input type="checkbox"/>	<input type="checkbox"/>	<input type="checkbox"/>	<input type="checkbox"/>	<input type="checkbox"/>	<input type="checkbox"/>
Input 4	<input type="checkbox"/>	<input type="checkbox"/>	<input type="checkbox"/>	<input type="checkbox"/>	<input type="checkbox"/>	<input type="checkbox"/>	<input type="checkbox"/>	<input type="checkbox"/>
Input 5	<input type="checkbox"/>	<input type="checkbox"/>	<input type="checkbox"/>	<input type="checkbox"/>	<input type="checkbox"/>	<input type="checkbox"/>	<input type="checkbox"/>	<input type="checkbox"/>
Input 6	<input type="checkbox"/>	<input type="checkbox"/>	<input type="checkbox"/>	<input type="checkbox"/>	<input type="checkbox"/>	<input type="checkbox"/>	<input type="checkbox"/>	<input type="checkbox"/>
Input 7	<input type="checkbox"/>	<input type="checkbox"/>	<input type="checkbox"/>	<input type="checkbox"/>	<input type="checkbox"/>	<input type="checkbox"/>	<input type="checkbox"/>	<input type="checkbox"/>
Input 8	<input type="checkbox"/>	<input type="checkbox"/>	<input type="checkbox"/>	<input type="checkbox"/>	<input type="checkbox"/>	<input type="checkbox"/>	<input type="checkbox"/>	<input type="checkbox"/>

Trouble signaled on outputs

	AC	NO BATTERY	LOW BATTERY	CABLE	S1	S2	OVERLOAD	EMAIL
Output 1	<input type="checkbox"/>	<input type="checkbox"/>	<input type="checkbox"/>	<input checked="" type="checkbox"/>	<input checked="" type="checkbox"/>	<input checked="" type="checkbox"/>	<input type="checkbox"/>	<input checked="" type="checkbox"/>
Output 2	<input checked="" type="checkbox"/>	<input checked="" type="checkbox"/>	<input checked="" type="checkbox"/>	<input type="checkbox"/>	<input type="checkbox"/>	<input type="checkbox"/>	<input checked="" type="checkbox"/>	<input type="checkbox"/>
Output 3	<input type="checkbox"/>	<input type="checkbox"/>	<input type="checkbox"/>	<input type="checkbox"/>	<input type="checkbox"/>	<input type="checkbox"/>	<input type="checkbox"/>	<input type="checkbox"/>
Output 4	<input type="checkbox"/>	<input type="checkbox"/>	<input type="checkbox"/>	<input type="checkbox"/>	<input type="checkbox"/>	<input type="checkbox"/>	<input type="checkbox"/>	<input type="checkbox"/>

AC power supply trouble delay [min] [0-255]
15

Control

	Input 1	Input 2	Input 3	Input 4	Input 5	Input 6	Input 7	Input 8	Operating time
Output 1	ON	No	ON	No	No	No	No	No	10 [Minutes]
Output 2	No	No	OFF	No	No	No	No	No	10 [Minutes]
Output 3	OFF	No	ON	No	No	No	No	No	5 [Minutes]
Output 4	No	No	No	No	No	No	No	No	0 [Seconds]

Fig. 7. „Inputs/outputs” tab.

4.6.2 Bypassing inputs

Each of the inputs can bypass other inputs.

Note: If the bypassing input which was violated is bypassed, the input bypassed by such a input will be restored.

4.6.3 Trouble signaled on outputs

Outputs can be activated after occurrence of the following troubles:

- Lack of AC supply (the trouble is reported with a delay which should be defined)
- Lack of battery
- Low battery
- Lack of Ethernet cable
- Problem with transmission to station 1
- Problem with transmission to station 2
- Supply output overload
- E-mail message sending failures

Note: The trouble signaling outputs cannot be controlled.

4.6.4 Control

Inputs can control outputs by activating or deactivating them.

Output operating time (after violation of the control input or after remote activation) should be programmed. The time can be programmed in seconds (up to 255 seconds) or minutes (up to 255 minutes). Programming 0 means that after violation of the input which activates the output, the output will remain active until violation of the input which deactivates the output.

4.7 „E-MAIL” TAB

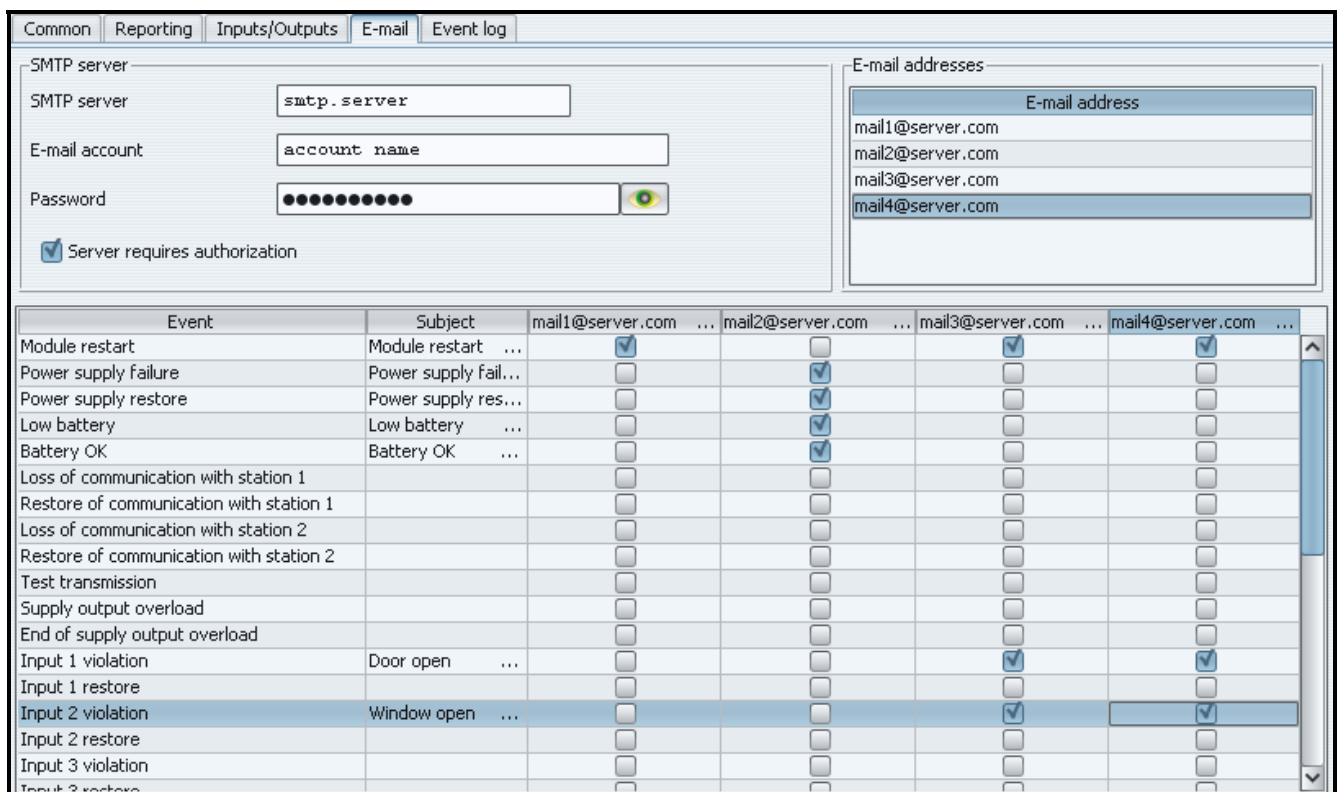

Fig. 8. „E-mail” tab.

4.7.1 SMTP server

SMTP server – enter in this field the SMTP server address (outgoing mail server).

Mail account – depending on the mail server settings, enter in this field the name of mail account or the full e-mail address of the mail account on the mail server.

Password – enter in this field the password used for authorization by the SMTP server (usually, this is the password used for downloading data from the incoming mail server (POP3)).

Server requires authorization – select this box, if the SMTP server requires authentication.

4.7.2 E-mail addresses

The e-mail messages can be sent to maximum 4 recipients, whose addresses are to be entered in corresponding fields.

4.7.3 Events

E-mail messages can be used for notification about the same module related events, the codes of which are reported to the monitoring station. If such an event occurs, you should define the subject of the outgoing message, as well as select the e-mail addresses to which the message will be sent.

4.8 „EVENT LOG” TAB

The tab displays the module event log, including both the events generated by the module and those received through the telephone line. The latter are designated by the ☞ symbol displayed in the "Tel." column. Shown in the "S1", "S2" and "M" columns is information on the event status. The symbols have the following meaning:

- + - event code/e-mail message has been sent;
- - event code/e-mail message is waiting to be sent;
- * - sending the event code/e-mail message has been cancelled (ETHM-2 module user has disabled monitoring events/sending e-mails after the event occurred).

5. TECHNICAL DATA

Nominal supply voltage:.....	16 V AC \pm 10% or 12 V DC \pm 15%
Power supply output current	1,2 A
Recommended battery.....	12 V / 7Ah
Battery charging current.....	350 mA
Current consumption, standby:	
DC supply	150 mA
AC supply	180 mA
Current consumption, maximum:	
DC supply	450 mA
AC supply	1,5 A
Current-carrying capacity, +12 V output	400 mA
Current-carrying capacity, OC type outputs	50 mA
Operating temperature range.....	0 ÷ 45 °C
Electronics board dimensions	68x120 mm
Weight.....	86 g

The latest EC declaration of conformity and certificates are available for downloading on our website www.satel.pl

